



## BOTTOM BREAKING BARS

WITH REPLACEABLE TIPS

### “EASY PULL” BAR

5/8” X 2”



- ◆ THE MOST EFFICIENT BOTTOM BREAKING BAR ON THE MARKET !

← ***BRYAN COMPANY EXCLUSIVE DESIGN !!!***

- ◆ ***THE CHROMIUM CARBIDE*** “EAGLE BEAK” IS LONG WEARING AND ATTACHES QUICKLY WITH A ROLL PIN.

### “HIGH CARBON” STANDARDS

HARDFACED TIP

5/8” X 2”

3/4” X 2 1/2”

- ◆ LONG TIP DESIGN TO PROTECT THE HIGH CARBON *STANDARD* FROM WEAR.
- ◆ ALSO AVAILABLE WITH WINGS
- ◆ REPLACABLE HARDFACED TIPS

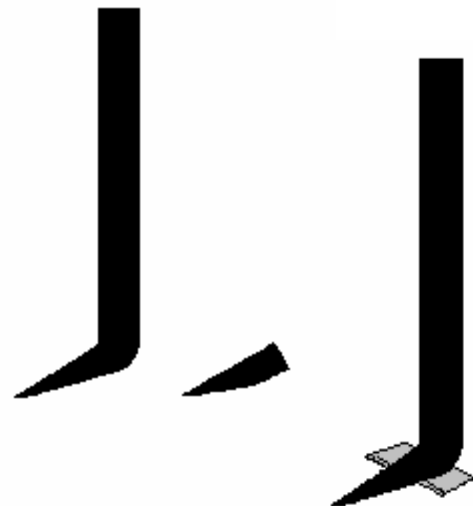

## BEARINGS



REPLACEMENT BEARING FOR AGRICULTURAL PRODUCTS

- ◆ CASE IH 770 / 780 DISC BEARINGS



- ◆ LILLISTON SPIDER ASSEMBLE BEARINGS

- ◆ BIG ED TAPERED ROLLER BEARINGS

***MORE !!!***

**BRYAN EQUIPMENT COMPANY**  
 GONZALES, CALIFORNIA    BEAVERTON, OREGON



# CLAMPS, STRAPS & SPACERS

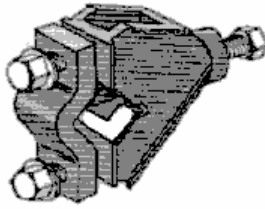

## CAST CLAMPS

*DOMESTIC AND IMPORTS*

5/8" X 2"

3/4" X 2 1/2"

1" X 3"

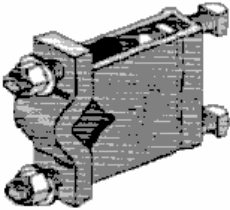

## FABRICATED CLAMPS

*DOMESTIC*

5/8" X 2"

3/4" X 2 1/2"

1" X 3"

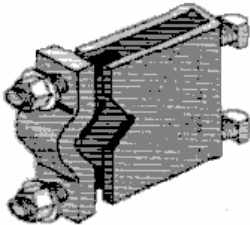

## FABRICATED "SUNDANCE" CLAMPS

BRYAN COMPANY'S OWN CUSTOM DESIGN

1" X 3"

1 1/4" X 3" HEAVY

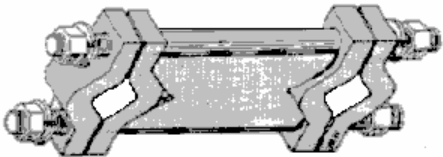

ASSORTMENT  
OF  
SHAPES & SIZES

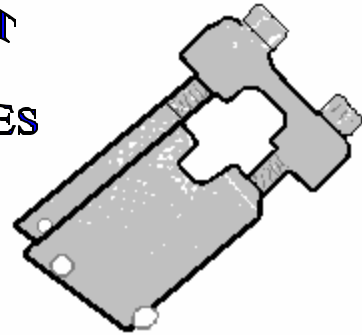

## TOOLBAR SPACERS

12" Medium & Heavy Duty

14" Medium & Heavy Duty

16" Medium Duty

## CLAMP STRAPS

*Many, Many to choose from !!!*

*INCLUDING*

*BRYAN COMPANY'S EXCLUSIVE*

*"ULTRA-HEAVY"*

*CAST STRAPS FOR PROFESSIONAL APPLICATORS*

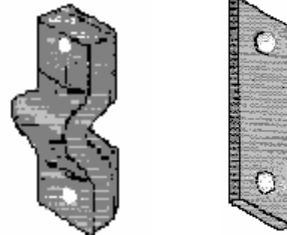

ASSORTED HOLE SIZES

**BRYAN EQUIPMENT COMPANY**  
GONZALES, CALIFORNIA ♦ BEAVERTON, OREGON



# CHROMIUM CARBIDE

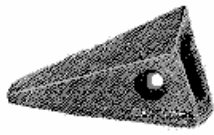

**ADVANCED  
EXCLUSIVE  
DESIGN**

## WEAR STRIPS

IN ALL SHAPES AND SIZES

- ◆ SUBSOILER CAPS
- ◆ SHIN GUARDS (FLAT)
- ◆ SHIN GUARDS (HALF-ROUND)
- ◆ LISTER POINT TIPS
- ◆ EAGLE BEAKS
- ◆ SWEEP EDGING
- ◆ CHISEL POINTS
- ◆ MULCHER TEETH
- ◆ FERTILIZER KNIFE INSERTS
- ◆ EXCLUSIVE SLED & SKID RUNNERS
- ◆ PLOW SHARE POINTS

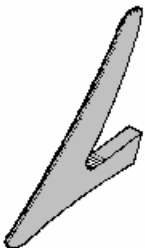
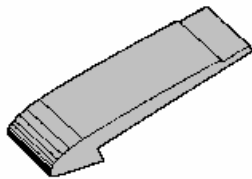
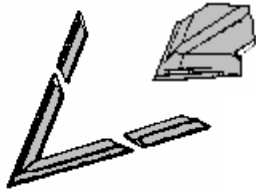

**MANY  
MANY  
MORE !!!**

## GRADER & SCRAPER BLADES



- ◆ SINGLE / DOUBLE BEVEL
- ◆ CURVED
- ◆ CUSTOM

**ALL MAKES &  
MODELS**



# SWEEPS, KNIVES & HOES

ENGLISH SHEFFIELD  
DOMESTIC

## HARDFACED SELF SHARPENING PLAIN ✕ DURAFACED

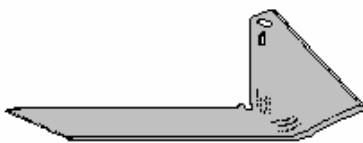
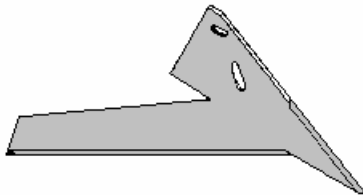
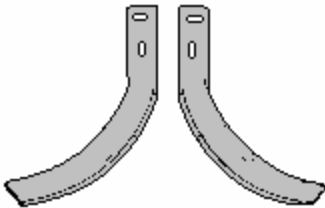
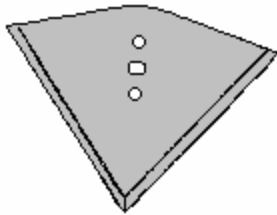
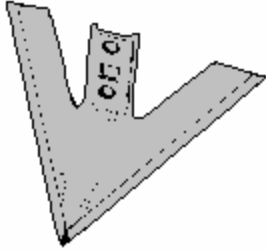

- ◆ DUCK FEET / CULTIVATOR SWEEPS
- ◆ ALABAMA SWEEPS
- ◆ SALINAS SIDE KNIVES
- ◆ TOP KNIVES / TENDER PLANT HOES
- ◆ BED KNIVES / JOHNSON & 2 PIECE
- ◆ ROUND SHOULDER BEET HOES
- ◆ BEAN & BEET HOES
- ◆ THINNERS & WEEDERS

◆ MANY KNIVES MADE SPECIFICALLY FOR THE VEGETABLE VALLEYS !!!

◆ ALL KNIVES ARE HEAT TREATED.

◆ ORGANIC FARMERS - WE HAVE SMALL WEEDERS & THINNERS FOR YOU.



**YOU WANT IT CUT  
WE HAVE A KNIFE!!!**

**BRYAN EQUIPMENT COMPANY**  
GONZALES, CALIFORNIA ◆ BEAVERTON, OREGON



# SHANKS, STANDARDS AND FOOTPIECES

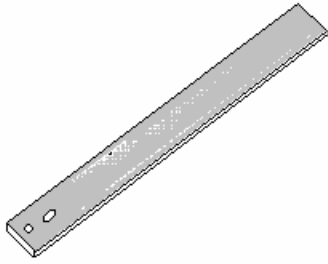

## *CULTIVATOR STANDARDS*

STRAIGHT ✕ OFFSET ✕ FOOTED

*ALL SIZES & CONFIGURATIONS*

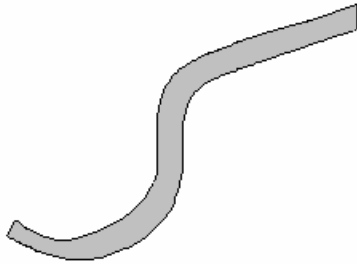

## *FOOTPIECES*

*CULTIVATING AND LISTER*

FABRICATED / ADJUSTABLE

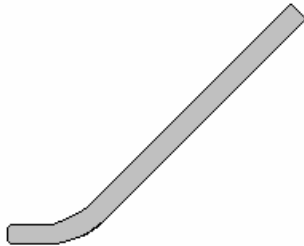

## **RIPPER SHANKS**

BIG ED ✕ DOMRIES ✕ A C ✕ SUNDANCE  
CUSTOM DESIGNS ✕ SUPERIOR STEELS

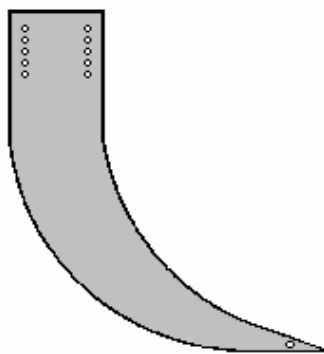
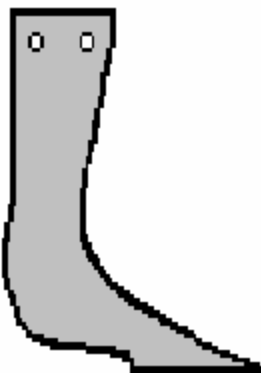

CALL ABOUT OUR NEWLY  
DESIGNED

**FLAT RUNNING SHANK!**



# DISC BLADES

SPECIALIZING IN

**EUROPEAN  
TERRA METAL**

BORON CHROMIUM ALLOY FOR EXTENDED WEAR

## DOMESTIC & IMPORTS

RAISED FLAT CENTERS

STANDARD CONCAVITY

NOTCHED / SMOOTH

HARDFACED ✕ DURAFACED ✕ PLAIN

ALL SIZES / ALL HOLES PATTERNS

## SPECIALTY ITEMS

DISC HILLERS ✕ ROW MARKERS ✕ CONE GUIDE WHEELS

## MINIMUM TILL

“SUNDANCE BLADES”

*OUR VERY OWN ADVANCED DESIGN*

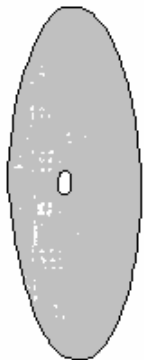
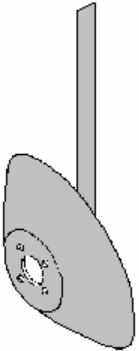

**ALSO**



ALLIS CHALMERS ◆ BUSH HOG ◆ FORD ◆ I.H. ◆ JOHN DEERE ◆ KRAUSE  
MASSEY FERGUSON ◆ MILLER ◆ TOWNER  
*OTHERS*

**BRYAN EQUIPMENT COMPANY**  
GONZALES, CALIFORNIA ◆ BEAVERTON, OREGON

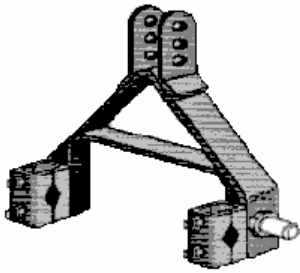

## THREE POINT ACCESSORIES

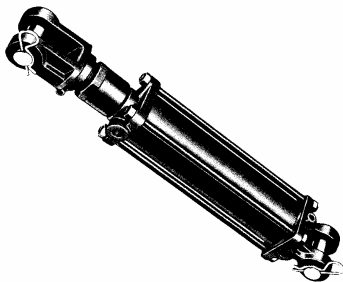
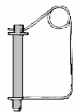
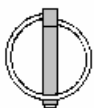
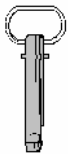
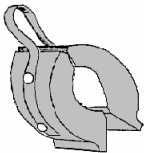
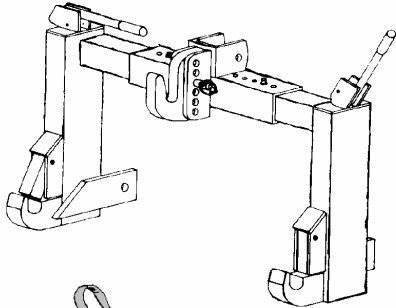

- ◆ A-FRAMES ( CATEGORY I, II & III )  
HEAVY & MEDIUM DUTY
- ◆ QUICK HITCH A-FRAMES  
HEAVY & MEDIUM DUTY
- ◆ FORGED LIFT ARMS
- ◆ LIFT ARM PINS
- ◆ LIFT ARM BALL SOCKETS
- ◆ FORGED TOP LINKS
- ◆ REPLACEMENT TOP LINK  
ENDS
- ◆ TOP LINK PINS
- ◆ HITCH PINS
- ◆ RED HEAD PINS
- ◆ LINCH PINS / CLEVIS PINS
- ◆ PTO LOCK PINS
- ◆ ROCKFORD HYDRAULIC CYLINDERS
- ◆ STROKE CONTROL BLOCKS
- ◆ PIONEER COUPLER / ADAPTERS

**LARGE  
INVENTORY**



## FERTILIZER & FUMIGATING EQUIPMENT

*EVERYTHING FOR THE “PROFESSIONAL”*



- ◆ DRY OR TEMIK INJECTION BLADES
- ◆ LIQUID INJECTION BLADES

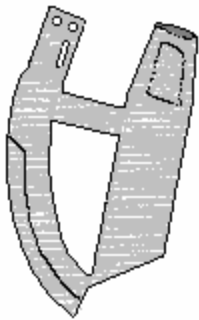

- ◆ FORWARD SWEEP FUMIGATING BLADES
- ◆ FLEXIBLE FERTILIZER HOSE & CLAMPS
- ◆ CROWDERS WITH CHROME

STATE OF THE ART *SELF-SHARPENING* HARDFACING

### *CHROMIUM CARBIDE INSERTS* PLANTING EQUIPMENT

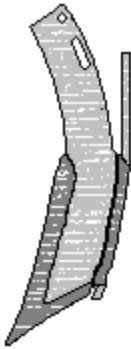

- ◆ SEED HOPPERS
- ◆ RUNNER OPENERS
- ◆ DRILLS
- ◆ SEED PLATES



**MANY OTHER  
SPECIALITY ITEMS !**





## SHOVELS

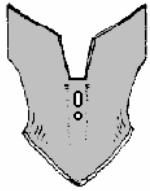

*HARDFACED SELF SHARPENING  
DURAFACED ✕ PLAIN  
HEAT TREATED*

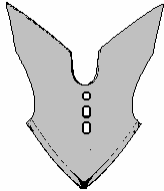

- ◆ HIGH WING
- ◆ STANDARD WING
- ◆ SNUB NOSE
- ◆ FURROWERS

*TAKE A LOOK  
AT OUR  
LISTER SECTION*

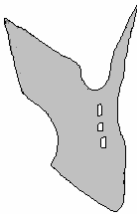

- ◆ MULES FOOT / IRRIGATION SHOVELS
- ◆ BERRY LISTING SHOVELS

## CHISEL POINTS

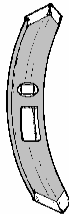

*PLAIN & HARDFACED SELF SHARPENING*

- ◆ SINGLE & DOUBLE POINTS
- ◆ ALL SIZES
- ◆ ONE / TWO & SLOTTED HOLES

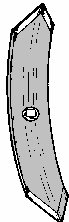

*MANY, MANY MORE  
LONG WEARING STEELS*

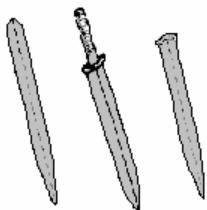

**HEAT TREATED**

## HARROW TEETH

1/2 5/8 3/4 HEADED & NON HEADED



# LISTER EQUIPMENT

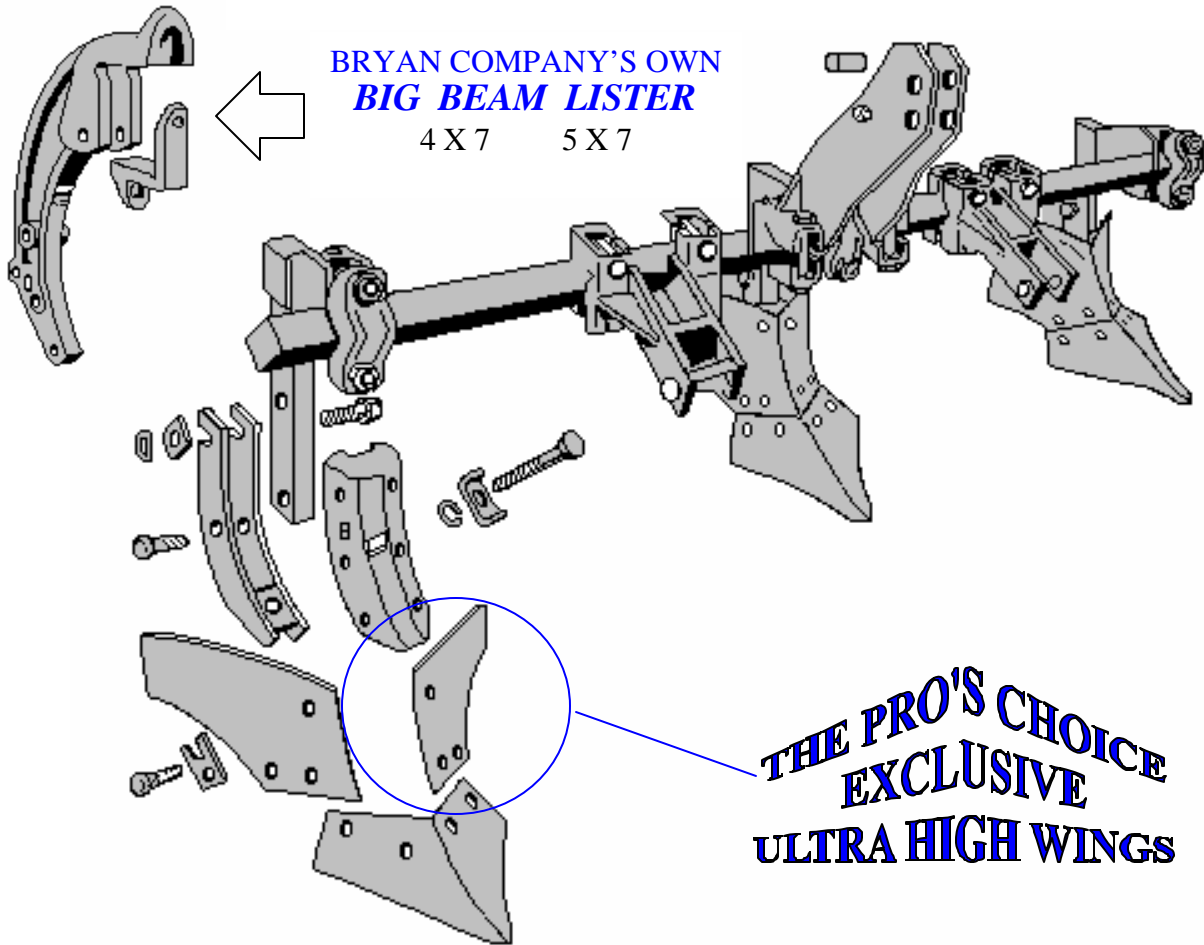

## *EVERYTHING FOR THE FARMER / APPLICATOR*

- ◆ LISTER BEAMS BARS 2¼ x 5X7 x 4X7
- ◆ LISTER STRAPS
- ◆ FOOTPIECES
- ◆ FROGS
- ◆ "U" STRAPS
- ◆ CLAMPS & STRAPS
- ◆ HOOK UP KIT
- ◆ NUTS & BOLTS
- ◆ SHARES
- ◆ WINGS (SPECIAL ULTRA-HIGH WINGS)
- ◆ MASTS, SPACERS & HITCHES

## REPLACEMENT PARTS FOR

I.H.

JOHN DEERE

MOLINE

***MANY OTHERS***

**BRYAN EQUIPMENT COMPANY**  
 GONZALES, CALIFORNIA ◆ BEAVERTON, OREGON



# PLOW PART HEADQUARTERS

BLADE SHARES ✕ SHINS ✕ MOLDBOARDS  
LANDSIDES ✕ TRASH PLATES ✕ FROGS



**"DEEP SUCK POINTS"  
THE GROWERS FAVORITE !!!**

**HARDFACED ✕ PLAIN**  
*CHROME POINTS & EDGING AVAILABLE*

◆ JOHN DEERE (ALL)



◆ IHC SUPER CHIEF / PLOW CHIEF

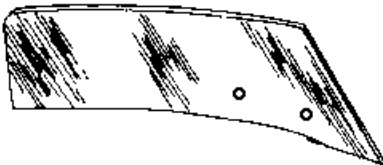

◆ OLIVER

◆ WILCOX

**MANY  
IN STOCK**

**ALSO AVAILABLE**



CASE ✕ AC ✕ FORD ✕ MASSEY FERGUSON  
MINNEAPOLIS MOLINE ✕ KVERNELAND  
WATTS LONG ✕ ATLAS



**CUSTOM DESIGNS TO  
INCREASE HEIGHT & ROLL**



**BRYAN EQUIPMENT COMPANY**  
GONZALES, CALIFORNIA ◆ BEAVERTON, OREGON

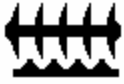

# CUTTING BLADES

## TILLERS ✕ FLAILS ✕ MOWERS



HEAT TREATED    HARDFACED    DURAFACED    PLAIN

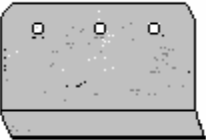

◆ BUTTONWILLOW

◆ KUHN

◆ BOMFORD

◆ LAND PRIDE

◆ DANDL

◆ MASCHIO

◆ FORD

◆ MC / MATHEWS

◆ GEARMORE

◆ NORTH WEST

◆ HOWARD

◆ RHINO

◆ JOHN DEERE

◆ SIDEWINDER

◆ JOHNSON INC.

◆ WOODS -HESSTON

◆ KUBOTA

◆ YANMAR

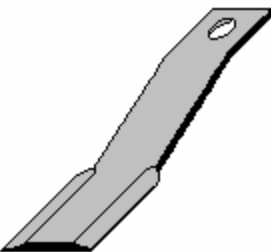

*BLADES FOR ALL MAKES AND MODELS*

*MANY, MANY ARE IN STOCK ITEMS*

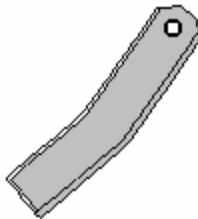
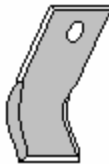
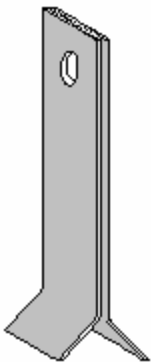

**BRYAN EQUIPMENT COMPANY**  
GONZALES, CALIFORNIA    ◆    BEAVERTON, OREGON



## GENERAL MERCHANDISE

- ◆ GOJO ORANGE HAND CLEANER
- ◆ LUBRIMATIC GREASE GUNS  
*PISTOL AND LEVER*
- ◆ BARREL PUMPS  
*FLUID TRANSFER SYSTEMS*
- ◆ IMPLEMENT JACKS
- ◆ HYDRA GRIPS
- ◆ CHAIN
- ◆ AGRICULTURAL HARDWARE

### McCoy Springs *OEM ALL MAJORS*

LEAF, HELPERS & COIL SPRINGS  
SHOCKS ✕ SHACKLE KITS  
SWAY BARS ✕ SUSPENSION PARTS  
AXLES & HALF AXLES  
**AUTOS - BUSES - TRUCKS**  
**TRAILERS - TRACTORS**

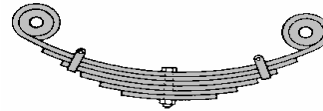

## HARDFACING

### **COBALARC** HARDFACING ELECTRODES

“SPECIFICALLY DESIGNED FOR AGRICULTURAL TILLAGE TOOLS”

- \*\* **COBALARC # 1 SPECIAL (CHROMIUM)** Ideal for hardfacing of all Agricultural tillage tools, rippers, dozers, fronts, mulchers, rotavators, plow shares...etc.
- \*\* **CHROMTUNG (CHROMIUM / TUNGSTEN) ACETYLENE / ELECTRIC-AC, DC.** Designed to resist wear on any HIGH ABRASION metals.
- \*\* **KT-150 ELECTRIC-AC, DC / PELLETUBE ACETYLENE (TUNGSTEN CARBIDE)**

**LOW AMPERAGE**  
**ROCKWELL MATRIX: 60-64**

## FASTENERS

- ◆ PLOW BOLTS
- ◆ CLIPPED HEAD BOLTS
- ◆ CARRIAGE BOLTS
- ◆ ROLL PINS
- ◆ WASHERS / LOCK WASHERS

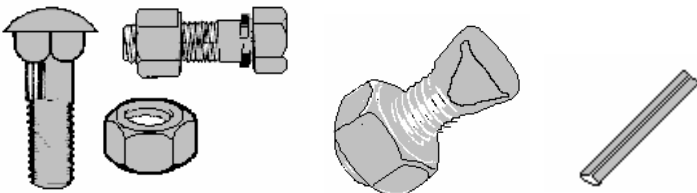

**GRADE 5**  
**GRADE 8**  
**AMERICAN MADE**

**BRYAN EQUIPMENT COMPANY**  
GONZALES, CALIFORNIA ◆ BEAVERTON, OREGON



# SPECIALITY & CUSTOM PRODUCTS



## LILLISTON SPIDERS

GANGS ✕ WHEELS ✕ BEARINGS ✕ PARTS  
PLAIN HARDFACED DURAFACED

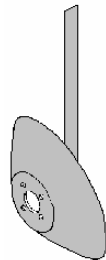

## RING ROLLERS

DOMESTIC & IMPORTED  
CAST & DUCTILE  
12" X 16" ✕ 14" X 20" ✕ 16" X 22"

## GAUGE WHEELS

RUBBER ✕ CONE ✕ STEEL

## SQUIRREL CAGES ✕ COULTERS

## GUIDE WHEELS

## DRIP TAPE INJECTORS

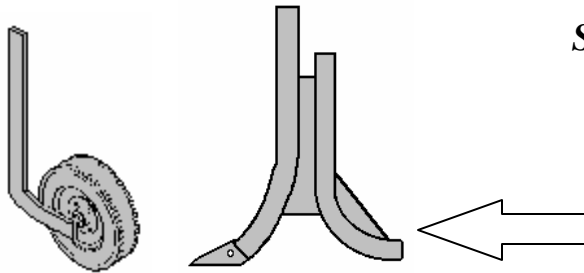

## SUBSOILER POINTS

HARDFACED ✕ CHROME ✕ WINGED ✕ PLAIN  
POINTS & BOOTS

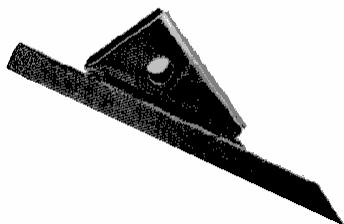
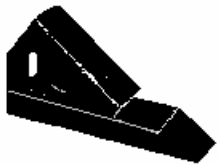

- ◆ A.C.
- ◆ BIG OX
- ◆ BIG ED
- ◆ DOMERIES
- ◆ J.D. KILIFER
- ◆ OXNARD
- ◆ SUNDANCE
- ◆ WILCOX

**SHATTER  
YOUR  
MATTER !!!**



# TRACTOR & ENGINE PARTS

**Allis Chalmers**

**Case**

**Ford**

**Hesston**

**International**

**John Deere**

**Kubota**

**Massey Ferguson**

**White**

***OTHERS***

**NEW &  
REMANUFACTURED**

- ◆ ENGINE KITS *CLEVITE*
- ◆ GASKET KITS *CLEVITE*
- ◆ FRONT-END PARTS
- ◆ HYDROSTATIC  
TRANSMISSION REBUILDS
- ◆ CLUTCHES
- ◆ PRESSURE PLATES
- ◆ PTO SHAFTS
- ◆ DRIVE LINES
- ◆ BRAKES
- ◆ FLYWHEELS
- ◆ WATER & HYDRAULIC  
PUMPS
- ◆ TURBOCHARGER REBUILDS
- ◆ PISTONS & RINGS

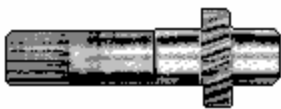

# MAN MORE ITEMS

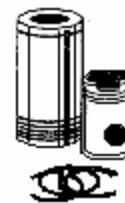

**CALL !!!**

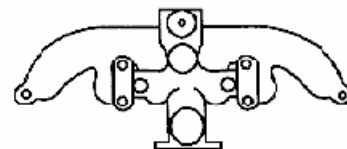
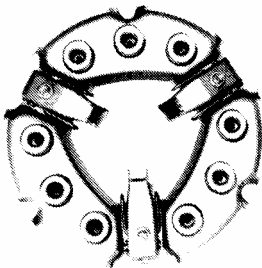

**BRYAN EQUIPMENT COMPANY**  
**GONZALES, CALIFORNIA ◆ BEAVERTON, OREGON**



## WHOLE GOODS SHORTLINE HEADQUARTERS

- ◆ TILLERS AND ROTOVATORS
- ◆ MOWERS AND SHREDDERS
- ◆ DISC HARROWS
- ◆ BED SHAPPERS AND SLEDS
- ◆ ROLLING CULTIVATORS
- ◆ CHISELS AND RIPPERS
- ◆ LAWN AND GARDEN EQUIP.
- ◆ REAR BLADES
- ◆ BOX SCRAPPERS
- ◆ TRACKING DEVICES
- ◆ LISTER RIGS

**WE CAN SOURCE  
MOST ANYTHING !!!**

### DISC HARROWS

- \* EXTRA **HEAVY** DESIGN
- \* **TIMKEN** TAPERED ROLLER BEARINGS
- \* BUILT FOR TODAY'S  
**HIGH-HORSEPOWER**
- \* HEAVIEST **FRAME** IN THE INDUSTRY

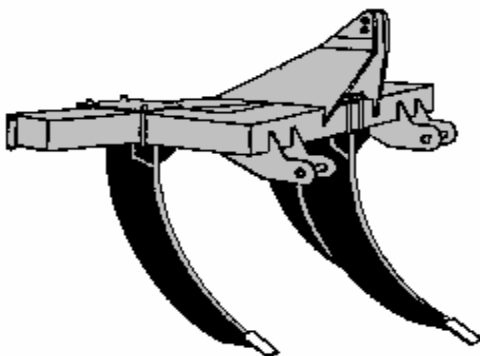

### RIPPERS

**NEW ADVANCED DESIGNED**

"EZ PULL" FLAT RUNNING SHANKS

**"SHATTERS LIKE AN  
UNDERGROUND TIDAL WAVE"**

THREE POINT OR PULL TYPE

40" CENTERS FOR RIPPING FURROWS  
OR  
OPEN FIELD CONFIGURATION

**BRYAN EQUIPMENT COMPANY**  
GONZALES, CALIFORNIA ◆ BEAVERTON, OREGON