



BOTTOM BREAKING BARS

WITH REPLACEABLE TIPS

“EASY PULL” BAR

5/8” X 2”

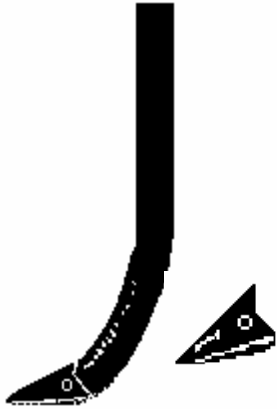

- ◆ THE MOST EFFICIENT BOTTOM BREAKING BAR ON THE MARKET !

← ***BRYAN COMPANY EXCLUSIVE DESIGN !!!***

- ◆ ***THE CHROMIUM CARBIDE*** “EAGLE BEAK” IS LONG WEARING AND ATTACHES QUICKLY WITH A ROLL PIN.

“HIGH CARBON” STANDARDS

HARDFACED TIP

5/8” X 2”

3/4” X 2 1/2”

- ◆ LONG TIP DESIGN TO PROTECT THE HIGH CARBON *STANDARD* FROM WEAR.
- ◆ ALSO AVAILABLE WITH WINGS
- ◆ REPLACABLE HARDFACED TIPS

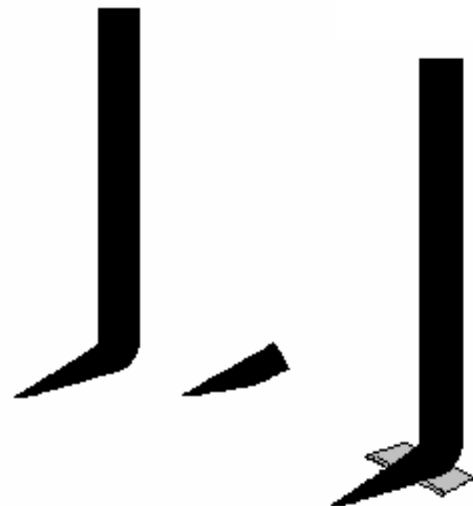

BEARINGS



REPLACEMENT BEARING FOR AGRICULTURAL PRODUCTS

- ◆ CASE IH 770 / 780 DISC BEARINGS



- ◆ LILLISTON SPIDER ASSEMBLE BEARINGS

- ◆ BIG ED TAPERED ROLLER BEARINGS

MORE !!!

BRYAN EQUIPMENT COMPANY
 GONZALES, CALIFORNIA BEAVERTON, OREGON



CLAMPS, STRAPS & SPACERS

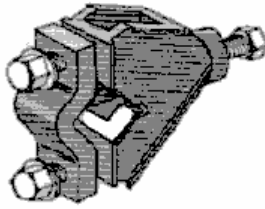

CAST CLAMPS

DOMESTIC AND IMPORTS

5/8" X 2"

3/4" X 2 1/2"

1" X 3"

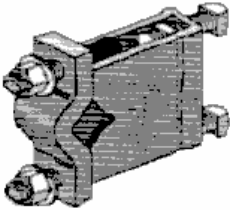

FABRICATED CLAMPS

DOMESTIC

5/8" X 2"

3/4" X 2 1/2"

1" X 3"

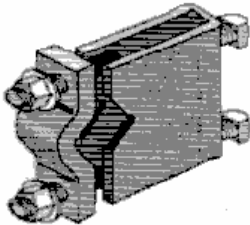

FABRICATED "SUNDANCE" CLAMPS

BRYAN COMPANY'S OWN CUSTOM DESIGN

1" X 3"

1 1/4" X 3" HEAVY

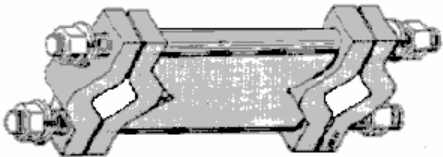

ASSORTMENT
OF
SHAPES & SIZES

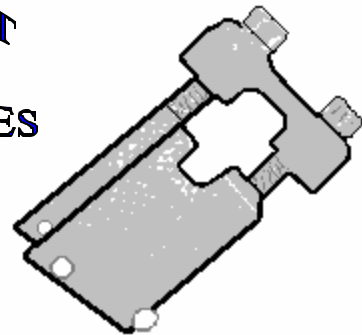

TOOLBAR SPACERS

12" Medium & Heavy Duty

14" Medium & Heavy Duty

16" Medium Duty

CLAMP STRAPS

Many, Many to choose from !!!

INCLUDING

BRYAN COMPANY'S EXCLUSIVE

"ULTRA-HEAVY"

CAST STRAPS FOR PROFESSIONAL APPLICATORS

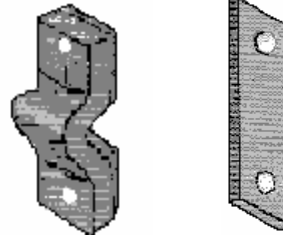

ASSORTED HOLE SIZES

BRYAN EQUIPMENT COMPANY
GONZALES, CALIFORNIA ♦ BEAVERTON, OREGON



CHROMIUM CARBIDE

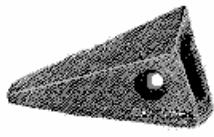

**ADVANCED
EXCLUSIVE
DESIGN**

WEAR STRIPS

IN ALL SHAPES AND SIZES

- ◆ SUBSOILER CAPS
- ◆ SHIN GUARDS (FLAT)
- ◆ SHIN GUARDS (HALF-ROUND)
- ◆ LISTER POINT TIPS
- ◆ EAGLE BEAKS
- ◆ SWEEP EDGING
- ◆ CHISEL POINTS
- ◆ MULCHER TEETH
- ◆ FERTILIZER KNIFE INSERTS
- ◆ EXCLUSIVE SLED & SKID RUNNERS
- ◆ PLOW SHARE POINTS

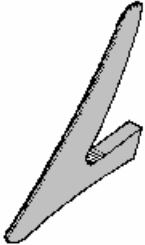
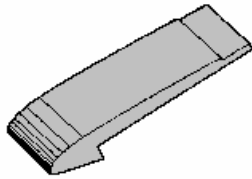
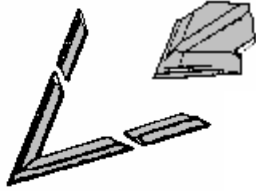

**MANY
MANY
MORE !!!**

GRADER & SCRAPER BLADES



- ◆ SINGLE / DOUBLE BEVEL
- ◆ CURVED
- ◆ CUSTOM

**ALL MAKES &
MODELS**



SWEEPS, KNIVES & HOES

ENGLISH SHEFFIELD
DOMESTIC

HARDFACED SELF SHARPENING PLAIN ✕ DURAFACED

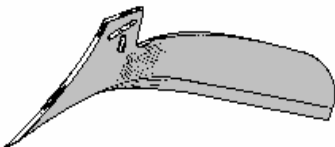
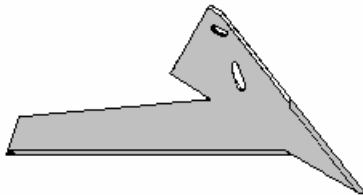
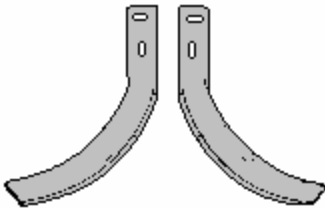
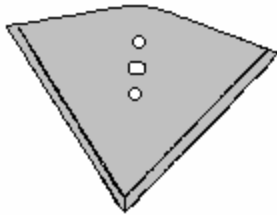
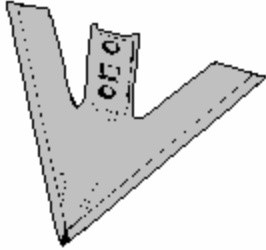

- ◆ DUCK FEET / CULTIVATOR SWEEPS
- ◆ ALABAMA SWEEPS
- ◆ SALINAS SIDE KNIVES
- ◆ TOP KNIVES / TENDER PLANT HOES
- ◆ BED KNIVES / JOHNSON & 2 PIECE
- ◆ ROUND SHOULDER BEET HOES
- ◆ BEAN & BEET HOES
- ◆ THINNERS & WEEDERS

◆ MANY KNIVES MADE SPECIFICALLY FOR THE VEGETABLE VALLEYS !!!

◆ ALL KNIVES ARE HEAT TREATED.

◆ ORGANIC FARMERS - WE HAVE SMALL WEEDERS & THINNERS FOR YOU.



**YOU WANT IT CUT
WE HAVE A KNIFE!!!**

BRYAN EQUIPMENT COMPANY
GONZALES, CALIFORNIA ◆ BEAVERTON, OREGON



SHANKS, STANDARDS AND FOOTPIECES

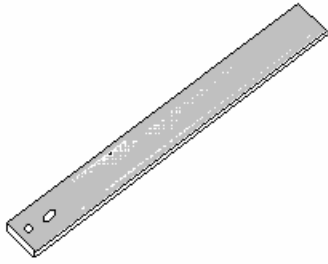

CULTIVATOR STANDARDS

STRAIGHT ✕ OFFSET ✕ FOOTED

ALL SIZES & CONFIGURATIONS

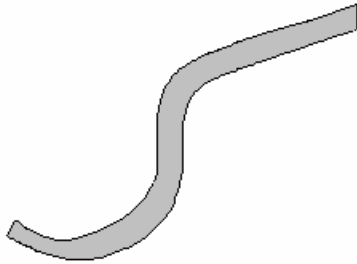

FOOTPIECES

CULTIVATING AND LISTER

FABRICATED / ADJUSTABLE

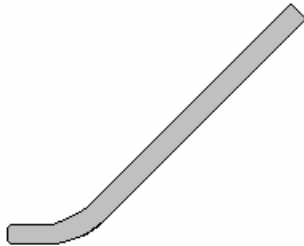

RIPPER SHANKS

BIG ED ✕ DOMRIES ✕ A C ✕ SUNDANCE
CUSTOM DESIGNS ✕ SUPERIOR STEELS

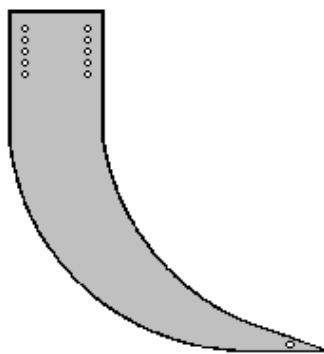
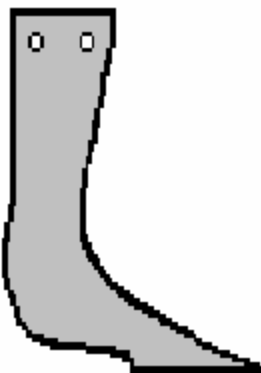

CALL ABOUT OUR NEWLY
DESIGNED

FLAT RUNNING SHANK!



DISC BLADES

SPECIALIZING IN

**EUROPEAN
TERRA METAL**

BORON CHROMIUM ALLOY FOR EXTENDED WEAR

DOMESTIC & IMPORTS

RAISED FLAT CENTERS

STANDARD CONCAVITY

NOTCHED / SMOOTH

HARDFACED ✕ DURAFACED ✕ PLAIN

ALL SIZES / ALL HOLES PATTERNS

SPECIALTY ITEMS

DISC HILLERS ✕ ROW MARKERS ✕ CONE GUIDE WHEELS

MINIMUM TILL

“SUNDANCE BLADES”

OUR VERY OWN ADVANCED DESIGN

ALSO



ALLIS CHALMERS ◆ BUSH HOG ◆ FORD ◆ I.H. ◆ JOHN DEERE ◆ KRAUSE
MASSEY FERGUSON ◆ MILLER ◆ TOWNER
OTHERS

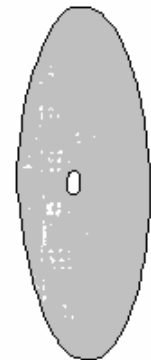

BRYAN EQUIPMENT COMPANY
GONZALES, CALIFORNIA ◆ BEAVERTON, OREGON

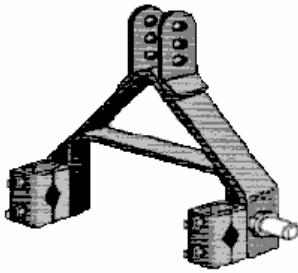

THREE POINT ACCESSORIES

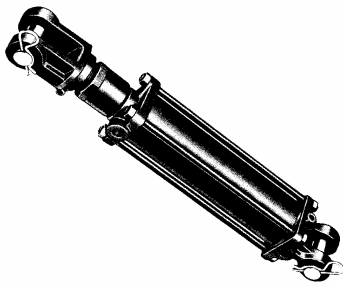
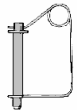
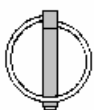
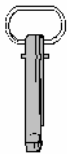
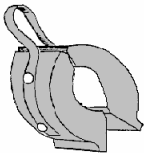
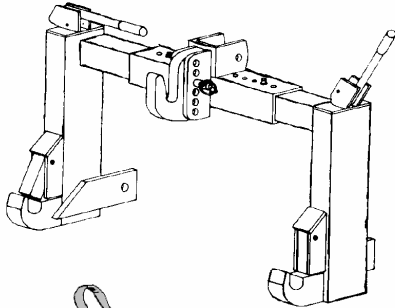

- ◆ A-FRAMES (CATEGORY I, II & III)
HEAVY & MEDIUM DUTY
- ◆ QUICK HITCH A-FRAMES
HEAVY & MEDIUM DUTY
- ◆ FORGED LIFT ARMS
- ◆ LIFT ARM PINS
- ◆ LIFT ARM BALL SOCKETS
- ◆ FORGED TOP LINKS
- ◆ REPLACEMENT TOP LINK
ENDS
- ◆ TOP LINK PINS
- ◆ HITCH PINS
- ◆ RED HEAD PINS
- ◆ LINCH PINS / CLEVIS PINS
- ◆ PTO LOCK PINS
- ◆ ROCKFORD HYDRAULIC CYLINDERS
- ◆ STROKE CONTROL BLOCKS
- ◆ PIONEER COUPLER / ADAPTERS

LARGE
INVENTORY



FERTILIZER & FUMIGATING EQUIPMENT

EVERYTHING FOR THE "PROFESSIONAL"



- ◆ DRY OR TEMIK INJECTION BLADES
- ◆ LIQUID INJECTION BLADES

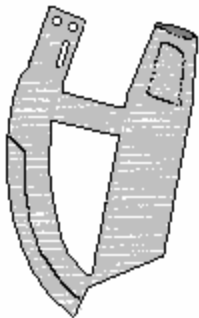

- ◆ FORWARD SWEEP FUMIGATING BLADES
- ◆ FLEXIBLE FERTILIZER HOSE & CLAMPS
- ◆ CROWDERS WITH CHROME

STATE OF THE ART *SELF-SHARPENING* HARDFACING

CHROMIUM CARBIDE INSERTS PLANTING EQUIPMENT



- ◆ SEED HOPPERS
- ◆ RUNNER OPENERS
- ◆ DRILLS
- ◆ SEED PLATES



**MANY OTHER
SPECIALITY ITEMS !**



SHOVELS

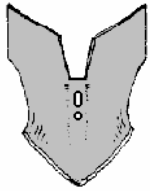

*HARDFACED SELF SHARPENING
DURAFACED ✕ PLAIN
HEAT TREATED*

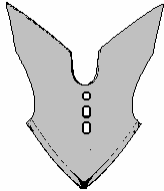

- ◆ HIGH WING
- ◆ STANDARD WING
- ◆ SNUB NOSE
- ◆ FURROWERS

*TAKE A LOOK
AT OUR
LISTER SECTION*

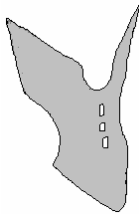

- ◆ MULES FOOT / IRRIGATION SHOVELS
- ◆ BERRY LISTING SHOVELS

CHISEL POINTS

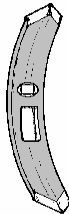

PLAIN & HARDFACED SELF SHARPENING

- ◆ SINGLE & DOUBLE POINTS
- ◆ ALL SIZES
- ◆ ONE / TWO & SLOTTED HOLES

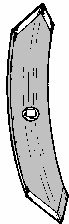

*MANY, MANY MORE
LONG WEARING STEELS*

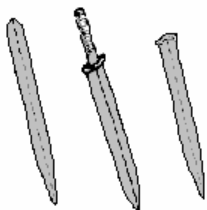

HEAT TREATED

HARROW TEETH

1/2 5/8 3/4 HEADED & NON HEADED



LISTER EQUIPMENT

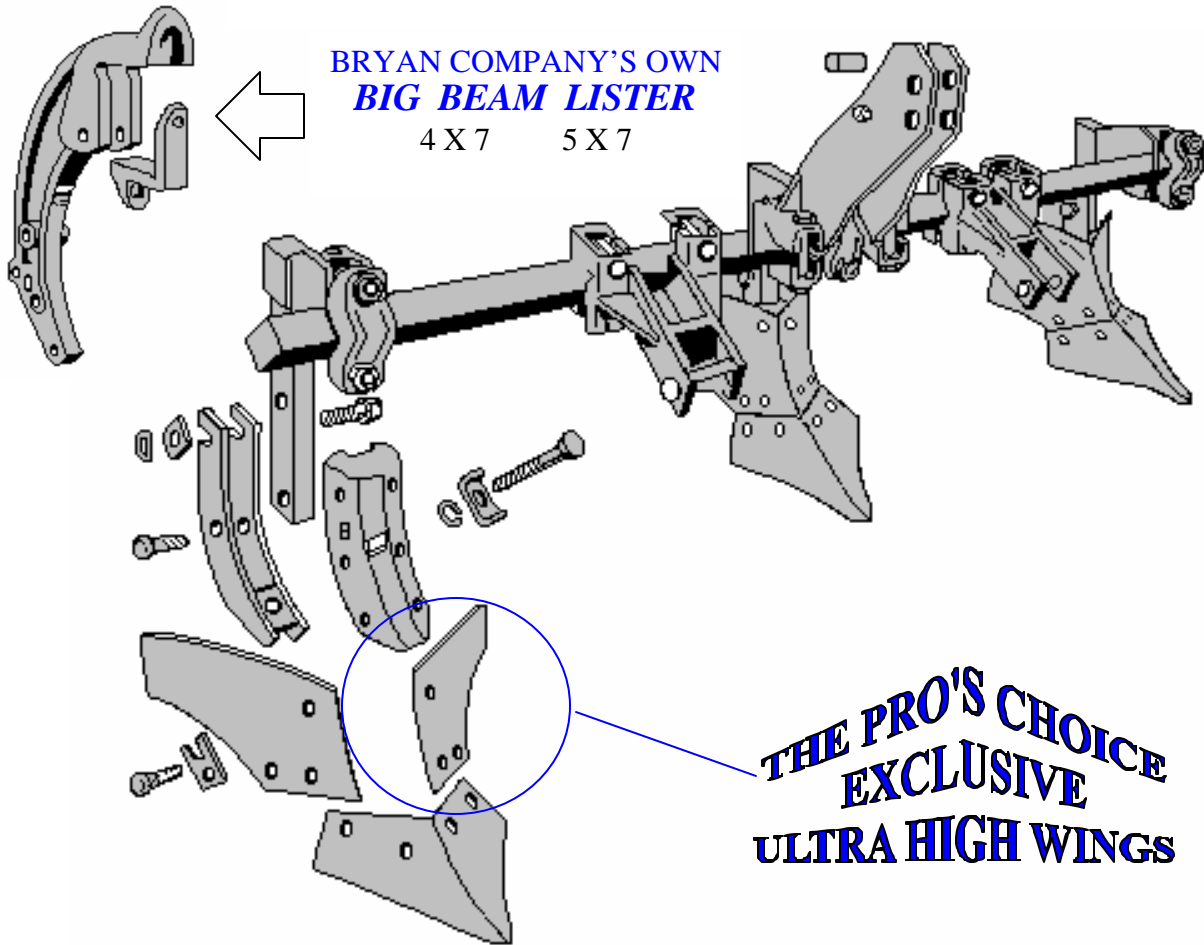

EVERYTHING FOR THE FARMER / APPLICATOR

- ◆ LISTER BEAMS BARS 2¼ x 5X7 x 4X7
- ◆ LISTER STRAPS
- ◆ FOOTPIECES
- ◆ FROGS
- ◆ "U" STRAPS
- ◆ CLAMPS & STRAPS
- ◆ HOOK UP KIT
- ◆ NUTS & BOLTS
- ◆ SHARES
- ◆ WINGS (SPECIAL ULTRA-HIGH WINGS)
- ◆ MASTS, SPACERS & HITCHES

REPLACEMENT PARTS FOR

I.H.

JOHN DEERE

MOLINE

MANY OTHERS

BRYAN EQUIPMENT COMPANY
 GONZALES, CALIFORNIA ◆ BEAVERTON, OREGON



PLOW PART HEADQUARTERS

BLADE SHARES ✕ SHINS ✕ MOLDBOARDS
LANDSIDES ✕ TRASH PLATES ✕ FROGS



**"DEEP SUCK POINTS"
THE GROWERS FAVORITE !!!**

HARDFACED ✕ PLAIN
CHROME POINTS & EDGING AVAILABLE

◆ JOHN DEERE (ALL)



◆ IHC SUPER CHIEF / PLOW CHIEF

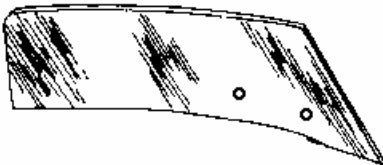

◆ OLIVER

◆ WILCOX

**MANY
IN STOCK**

ALSO AVAILABLE



CASE ✕ AC ✕ FORD ✕ MASSEY FERGUSON
MINNEAPOLIS MOLINE ✕ KVERNELAND
WATTS LONG ✕ ATLAS



**CUSTOM DESIGNS TO
INCREASE HEIGHT & ROLL**



BRYAN EQUIPMENT COMPANY
GONZALES, CALIFORNIA ◆ BEAVERTON, OREGON



CUTTING BLADES

TILLERS ✕ FLAILS ✕ MOWERS



HEAT TREATED HARDFACED DURAFACED PLAIN

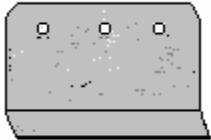

◆ BUTTONWILLOW

◆ KUHN

◆ BOMFORD

◆ LAND PRIDE

◆ DANDL

◆ MASCHIO

◆ FORD

◆ MC / MATHEWS

◆ GEARMORE

◆ NORTH WEST

◆ HOWARD

◆ RHINO

◆ JOHN DEERE

◆ SIDEWINDER

◆ JOHNSON INC.

◆ WOODS -HESSTON

◆ KUBOTA

◆ YANMAR

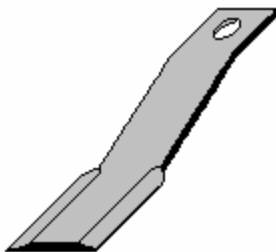

BLADES FOR ALL MAKES AND MODELS

MANY, MANY ARE IN STOCK ITEMS

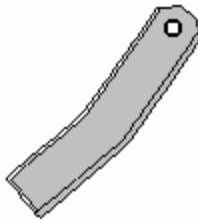
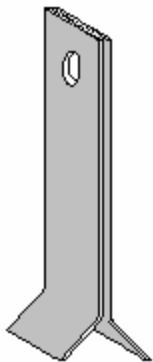

BRYAN EQUIPMENT COMPANY
GONZALES, CALIFORNIA ◆ BEAVERTON, OREGON



GENERAL MERCHANDISE

- ◆ GOJO ORANGE HAND CLEANER
- ◆ LUBRIMATIC GREASE GUNS
PISTOL AND LEVER
- ◆ BARREL PUMPS
FLUID TRANSFER SYSTEMS
- ◆ IMPLEMENT JACKS
- ◆ HYDRA GRIPS
- ◆ CHAIN
- ◆ AGRICULTURAL HARDWARE

McCoy Springs *OEM ALL MAJORS*

LEAF, HELPERS & COIL SPRINGS
SHOCKS ✕ SHACKLE KITS
SWAY BARS ✕ SUSPENSION PARTS
AXLES & HALF AXLES
AUTOS - BUSES - TRUCKS
TRAILERS - TRACTORS

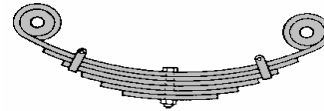

HARDFACING

COBALARC HARDFACING ELECTRODES

“SPECIFICALLY DESIGNED FOR AGRICULTURAL TILLAGE TOOLS”

- ** **COBALARC # 1 SPECIAL (CHROMIUM)** Ideal for hardfacing of all Agricultural tillage tools, rippers, dozers, fronts, mulchers, rotavators, plow shares...etc.
- ** **CHROMTUNG (CHROMIUM / TUNGSTEN) ACETYLENE / ELECTRIC-AC, DC.** Designed to resist wear on any HIGH ABRASION metals.
- ** **KT-150 ELECTRIC-AC, DC / PELLETUBE ACETYLENE (TUNGSTEN CARBIDE)**

LOW AMPERAGE
ROCKWELL MATRIX: 60-64

FASTENERS

- ◆ PLOW BOLTS
- ◆ CLIPPED HEAD BOLTS
- ◆ CARRIAGE BOLTS
- ◆ ROLL PINS
- ◆ WASHERS / LOCK WASHERS

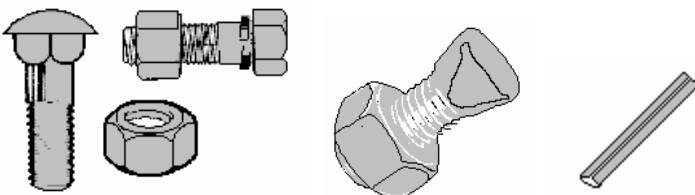

GRADE 5
GRADE 8
AMERICAN MADE

BRYAN EQUIPMENT COMPANY
GONZALES, CALIFORNIA ◆ BEAVERTON, OREGON



SPECIALITY & CUSTOM PRODUCTS



LILLISTON SPIDERS

GANGS ✕ WHEELS ✕ BEARINGS ✕ PARTS
PLAIN HARDFACED DURAFACED

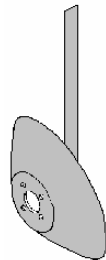

RING ROLLERS

DOMESTIC & IMPORTED
CAST & DUCTILE
12" X 16" ✕ 14" X 20" ✕ 16" X 22"

GAUGE WHEELS

RUBBER ✕ CONE ✕ STEEL

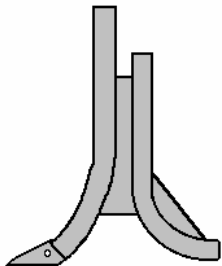
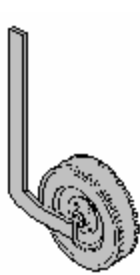

SQUIRREL CAGES ✕ COULTERS

GUIDE WHEELS

DRIP TAPE INJECTORS

SUBSOILER POINTS

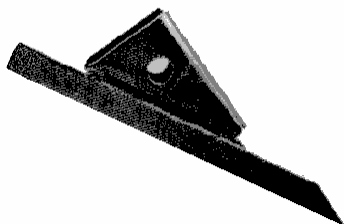
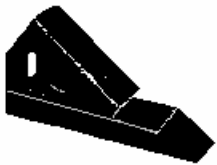

HARDFACED ✕ CHROME ✕ WINGED ✕ PLAIN
POINTS & BOOTS

- ◆ A.C.
- ◆ BIG OX
- ◆ BIG ED
- ◆ DOMERIES
- ◆ J.D. KILIFER
- ◆ OXNARD
- ◆ SUNDANCE
- ◆ WILCOX

**SHATTER
YOUR
MATTER !!!**



TRACTOR & ENGINE PARTS

Allis Chalmers

Case

Ford

Hesston

International

John Deere

Kubota

Massey Ferguson

White

OTHERS

**NEW &
REMANUFACTURED**

- ◆ ENGINE KITS *CLEVITE*
- ◆ GASKET KITS *CLEVITE*
- ◆ FRONT-END PARTS
- ◆ HYDROSTATIC
TRANSMISSION REBUILDS
- ◆ CLUTCHES
- ◆ PRESSURE PLATES
- ◆ PTO SHAFTS
- ◆ DRIVE LINES
- ◆ BRAKES
- ◆ FLYWHEELS
- ◆ WATER & HYDRAULIC
PUMPS
- ◆ TURBOCHARGER REBUILDS
- ◆ PISTONS & RINGS



MAN MORE ITEMS

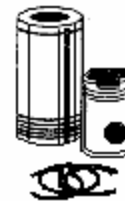

CALL !!!

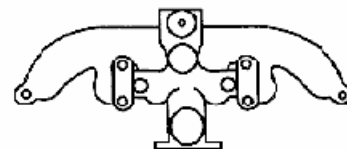
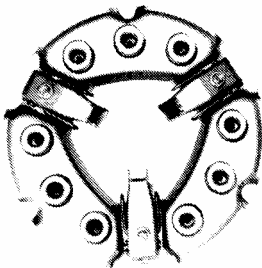

BRYAN EQUIPMENT COMPANY
GONZALES, CALIFORNIA ◆ BEAVERTON, OREGON



WHOLE GOODS SHORTLINE HEADQUARTERS

- ◆ TILLERS AND ROTOVATORS
- ◆ MOWERS AND SHREDDERS
- ◆ DISC HARROWS
- ◆ BED SHAPPERS AND SLEDS
- ◆ ROLLING CULTIVATORS
- ◆ CHISELS AND RIPPERS
- ◆ LAWN AND GARDEN EQUIP.
- ◆ REAR BLADES
- ◆ BOX SCRAPPERS
- ◆ TRACKING DEVICES
- ◆ LISTER RIGS

**WE CAN SOURCE
MOST ANYTHING !!!**

DISC HARROWS

- * EXTRA **HEAVY** DESIGN
- * **TIMKEN** TAPERED ROLLER BEARINGS
- * BUILT FOR TODAY'S
HIGH-HORSEPOWER
- * HEAVIEST **FRAME** IN THE INDUSTRY

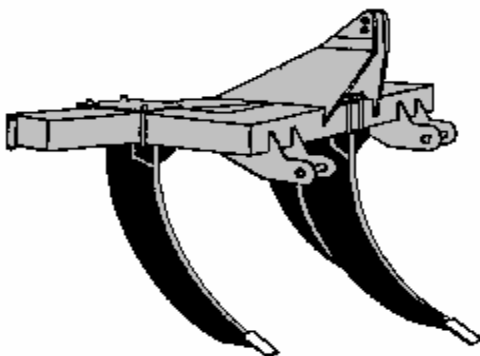
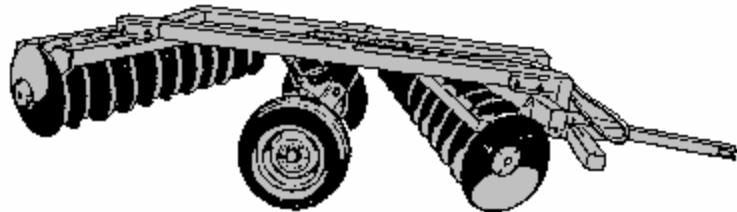

RIPPERS

NEW ADVANCED DESIGNED

"EZ PULL" FLAT RUNNING SHANKS

**"SHATTERS LIKE AN
UNDERGROUND TIDAL WAVE"**

THREE POINT OR PULL TYPE

40" CENTERS FOR RIPPING FURROWS
OR
OPEN FIELD CONFIGURATION

BRYAN EQUIPMENT COMPANY
GONZALES, CALIFORNIA ◆ BEAVERTON, OREGON